

Article number: 20343225M863KS

Description: E+G Levelling foot  
GN 343.2-25-M8-63-KS

Note: 0

## Measures

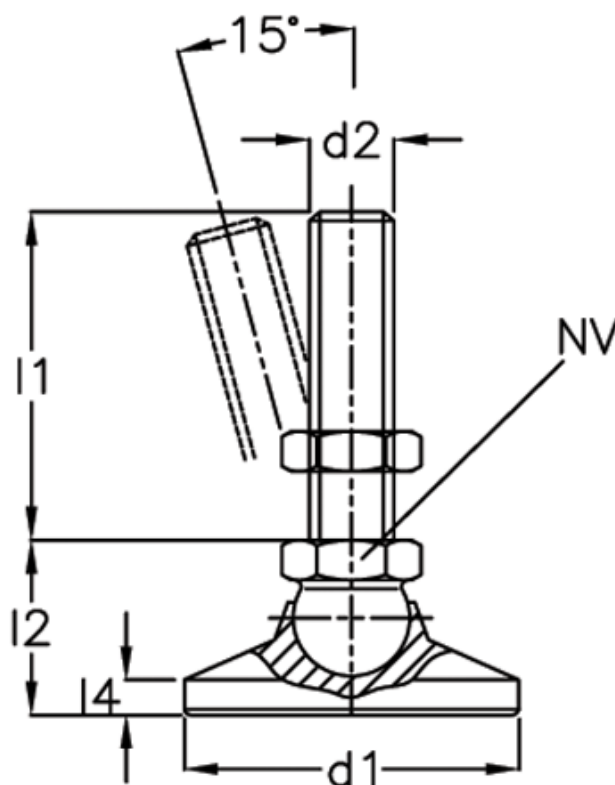

d1 = 25

d2 = M8

l1 = 63

l2 = -

l3 = 20.5

l4 = -

l5 = 5.5

NV = 12

Static load = 14

Weight in (g) = 65